

**135G
Excavator
Operation and Test
(PIN: 1FF135GX_ _F500001—)**

**OPERATION & TEST TECHNICAL
MANUAL**

**135G Excavator (PIN: 1FF135GX_
_F500001—)**

TM14053X19 18JUN19 (ENGLISH)

Introduction

Foreword

This manual is written for an experienced technician. Essential tools required in performing certain service work are identified in this manual and are recommended for use.

Live with safety: Read the safety messages in the introduction of this manual and the cautions presented throughout the text of the manual.

 This is the safety-alert symbol. When this symbol is seen on the machine or in this manual, be alert for the potential of personal injury.

Technical manuals are divided in two parts: repair and operation and tests. Repair sections tell how to repair the components. Operation and test sections help to quickly identify the majority of routine failures quickly.

Information is organized in groups for the various components requiring service instruction. At the beginning of each group are summary listings of all applicable essential tools, service equipment and tools, other materials needed to do the job, service parts kits, specifications, wear tolerances, and torque values.

Technical manuals are concise guides for specific machines. They are on-the-job guides containing only the vital information needed for diagnosis, analysis, testing, and repair.

Fundamental service information is available from other sources covering basic theory of operation, fundamentals of troubleshooting, general maintenance, and basic type of failures and their causes.

MM16284.00026ED -19-17SEP18-1/1

Manual Identification—READ THIS FIRST!

IMPORTANT: Use only supporting manuals designated for each specific machine. If incorrect manual is chosen, improper service may occur. Verify product identification number (PIN) when choosing the correct manual.

Choosing the Correct Supporting Manuals

John Deere machines are available in different machine configurations based on the various markets into which they are sold. Different supporting manuals exist for different machine configurations.

When necessary, product identification numbers are listed on the front covers of the manuals. These numbers are used to identify the correct supporting manual for the machine.

Product Identification Number

The product identification number (PIN) plate (1) is located on the front, right corner of the cab. Each machine has a 17-character PIN (2) shown on PIN plate.

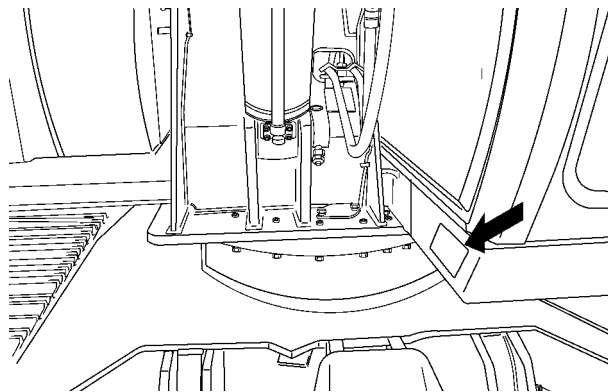

PIN Plate Location

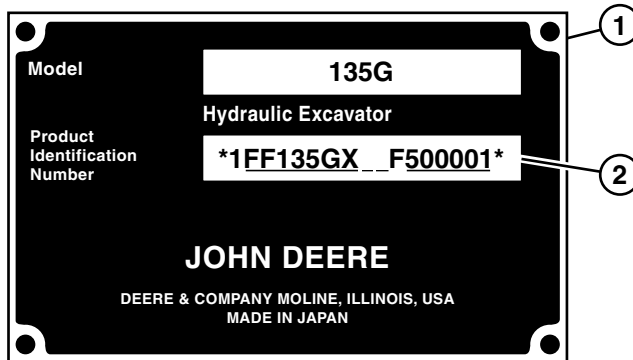

Example of PIN Plate

1— PIN Plate

2— 17-Character PIN

T151806—UN—25FEB02

TX1211354—UN—08APR16

The PIN identifies the producing factory, machine model number, machine option, year of manufacture, engine emission level, and machine serial number.

The following is an example for a machine that meets Final Tier 4 and Stage IV emission levels:

17-Character PIN Examples																
1	2	3	4	5	6	7	8	9	10	11	12	13	14	15	16	17
1	F	F	1	3	5	G	X	-	-	F	5	0	0	0	0	1

• **(1—3) World Code:** Identifies location where machine is manufactured.

1FF **World Code** (manufacturing location)

1DW Davenport Works

1T8 Thibodaux Works

1T0 Dubuque Works

1FF Deere—Hitachi (Kernersville, NC, USA)

1F9 Deere—Hitachi (Indaiatuba, São Paulo, Brazil)

• **(4—8) Machine Model and Series Identifier:** Identifies model number and series.

135G **Machine Model and Series Identifier**

NOTE: Characters 7—8 identify series and major machine configuration options. These characters will change from one machine to another.

X..... **Machine Option Code** (variable)

X Base Machine Model

• **(9) Check Letter:** This is a random character assigned by the factory. This is not used in machine identification.

- **Check Letter** (variable)

• **(10) Manufacturing Year Code:** Identifies year of machine manufacture.

- **Manufacturing Year Code** (variable)

D 2013

E 2014

F 2015

G 2016

• **(11) Engine Emission Code:** Represents engine emission certification.

F **Engine Emission Code**

C Tier 2 and Stage II

D Tier 3 and Stage III A

E Interim Tier 4 and Stage III B

F Final Tier 4 and Stage IV

G Interim Tier 4 and Stage III A (19-56 kW)

H Final Tier 4 and Stage III A (19-37 kW)

J Final Tier 4 and Stage III B (37-56 kW)

K Final Tier 4 (8-19 kW)

• **(12—17) Machine Serial Number:** Identifies machine serial number. This character will change from one machine to another.

500001 **Machine Serial Number**

Contents

Section 9000—General Information

Group 01—Safety

Section 9001—Diagnostics

Group 10—Main Controller (MCZ) Diagnostic Trouble Codes

Group 20—Engine Control Module (ECM) Diagnostic Trouble Codes

Group 30—Monitor Controller (DSZ) Diagnostic Trouble Codes

Group 40—Information Controller (ICZ) Diagnostic Trouble Codes

Group 50—Air Conditioner Controller (ACF) Diagnostic Trouble Codes

Section 9005—Operational Checkout Procedure

Group 10—Operational Checkout Procedure

Section 9010—Engine

Group 05—Theory of Operation

Group 15—Diagnostic Information

Group 20—Adjustments

Group 25—Tests

Section 9015—Electrical System

Group 05—System Information

Group 10—System Diagrams

Group 15—Sub-System Diagnostics

Group 16—Monitor Operation

Group 20—References

Section 9020—Power Train

Group 05—Theory of Operation

Group 15—Diagnostic Information

Section 9025—Hydraulic System

Group 05—Theory of Operation

Group 15—Diagnostic Information

Group 25—Tests

Section 9031—Heating and Air Conditioning

Group 05—Theory of Operation

Group 15—Diagnostic Information

Group 25—Tests

Section 9900—Dealer Fabricated Tools

Group 99—Dealer Fabricated Tools

Original Instructions. All information, illustrations and specifications in this manual are based on the latest information available at the time of publication. The right is reserved to make changes at any time without notice.

COPYRIGHT © 2019
DEERE & COMPANY
Moline, Illinois
All rights reserved.
A John Deere ILLUSTRATION™ Manual
Previous Editions
Copyright © 2016, 2017, 2018

**Thanks very much for your reading,
Want to get more information,
Please click here, Then get the complete
manual**

JustClickHere 

NOTE:

**If there is no response to click on the link above,
please download the PDF document first, and then
click on it.**

**Have any questions please write to me:
admin@servicemanualperfect.com**

Section 9000 General Information

Contents

	Page		Page
Group 01—Safety			
Recognize Safety Information	9000-01-1	Clean Exhaust Filter Safely	9000-01-16
Follow Safety Instructions.....	9000-01-1		
Operate Only If Qualified	9000-01-1		
Wear Protective Equipment.....	9000-01-2		
Avoid Unauthorized Machine Modifications.....	9000-01-2		
Control Pattern Selector—If Equipped	9000-01-2		
Inspect Machine	9000-01-2		
Stay Clear of Moving Parts.....	9000-01-3		
Avoid High-Pressure Fluids	9000-01-3		
Avoid High-Pressure Oils	9000-01-3		
Work In Ventilated Area.....	9000-01-4		
Avoid Static Electricity Risk When Refueling	9000-01-4		
Prevent Fires	9000-01-5		
In Case of Machine Fire	9000-01-5		
Prevent Battery Explosions	9000-01-6		
Handle Chemical Products Safely.....	9000-01-6		
Handle Starting Fluid Safely	9000-01-6		
Decommissioning — Proper Recycling and Disposal of Fluids and Components	9000-01-7		
Exhaust Filter Ash Handling and Disposal.....	9000-01-7		
Prepare for Emergencies.....	9000-01-7		
Clean Debris from Machine	9000-01-8		
Add Cab Guarding for Special Uses	9000-01-8		
Use Steps and Handholds Correctly	9000-01-8		
Start Only From Operator's Seat	9000-01-8		
Use and Maintain Seat Belt.....	9000-01-9		
Prevent Unintended Machine Movement.....	9000-01-9		
Avoid Work Site Hazards.....	9000-01-10		
Keep Riders Off Machine	9000-01-10		
Avoid Backover Accidents	9000-01-11		
Avoid Machine Tip Over	9000-01-11		
Use Special Care When Lifting Objects	9000-01-12		
Inspect and Maintain ROPS	9000-01-12		
Travel Safely.....	9000-01-12		
Prevent Acid Burns.....	9000-01-13		
Add and Operate Attachments Safely.....	9000-01-13		
Park and Prepare for Service Safely.....	9000-01-14		
Service Cooling System Safely	9000-01-14		
Remove Paint Before Welding or Heating	9000-01-15		
Make Welding Repairs Safely	9000-01-15		
Drive Metal Pins Safely	9000-01-15		

Recognize Safety Information

This is the safety alert symbol. When you see this symbol on your machine or in this manual, be alert for the potential of personal injury.

Follow the precautions and safe operating practices highlighted by this symbol.

A signal word — DANGER, WARNING, or CAUTION — is used with the safety alert symbol. DANGER identifies the most serious hazards.

On your machine, DANGER signs are red in color, WARNING signs are orange, and CAUTION signs are yellow. DANGER and WARNING signs are located near specific hazards. General precautions are on CAUTION labels.



T133555 —UN—15APR13

T133588 —19—28AUG00

TX,RECOGNIZE -19-28JUN10-1/1

Follow Safety Instructions

Carefully read all safety messages in this manual and on your machine safety signs. Keep safety signs in good condition. Replace missing or damaged safety signs. Use this operator's manual for correct safety sign placement. Be sure that new equipment components and repair parts include the current safety signs. Replacement safety signs are available from your John Deere dealer.

There can be additional safety information contained on parts and components sourced from suppliers that is not reproduced in this operator's manual.

Learn how to operate the machine and how to use controls properly. Do not let anyone operate without instruction.

Keep your machine in proper working condition. Unauthorized modifications to the machine could impair the function or safety and affect machine life.



If you do not understand any part of this manual and need assistance, contact your John Deere dealer.

TS201 —UN—15APR13

TX,FOLLOW -19-20JAN11-1/1

Operate Only If Qualified

Do not operate this machine unless the operator's manual has been read carefully, and you have been qualified by supervised training and instruction.

Operator should be familiar with the job site and surroundings before operating. Try all controls and

machine functions with the machine in an open area before starting to work.

Know and observe all safety rules that may apply to every work situation and work site.

TX,QUALIFIED -19-18JAN11-1/1

Wear Protective Equipment

Guard against injury from flying pieces or metal or debris; wear goggles or safety glasses.

Wear close fitting clothing and safety equipment appropriate to the job.

Operating equipment safely requires the full attention of the operator. Do not wear radio or music headphones while operating machine.

Prolonged exposure to loud noise can cause impairment or loss of hearing. Wear suitable hearing protection such as earmuffs or earplugs to protect against objectionable or uncomfortable loud noises. Radio or music headphones are not suitable to use for hearing protection.

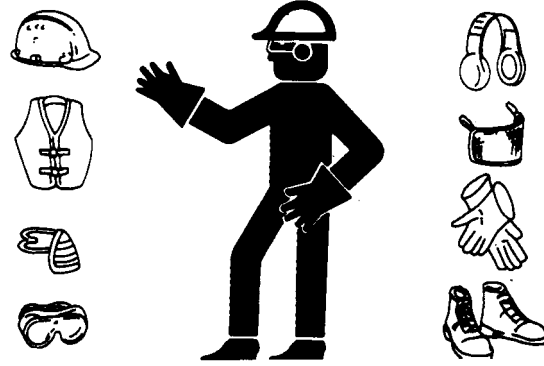

TS206—UN—15APR13

TX,WEAR,PE -19-22SEP10-1/1

Avoid Unauthorized Machine Modifications

John Deere recommends using only genuine John Deere replacement parts to ensure machine performance. Never substitute genuine John Deere parts with alternate parts not intended for the application as these can create hazardous situations or hazardous performance. Non-John Deere parts, or any damage or malfunctions resulting from their use, are not covered by any John Deere warranty.

Modifications to this machine or addition of unapproved products or attachments may affect machine stability or

reliability and may create a hazard for the operator or others near the machine. The installer of any modification that may affect the electronic controls of this machine is responsible for establishing that the modification does not adversely affect the machine or its performance.

Always contact an authorized dealer before making machine modifications that change the intended use, weight, or balance of the machine or that alter machine controls, performance, or reliability.

KR46761,00010A9 -19-19FEB19-1/1

Control Pattern Selector—If Equipped

This machine may be equipped with a control pattern selector valve. Ensure all bystanders are clear of machine

and area is large enough to operate machine functions. Verify the machine response to each control movement.

DB84312,00000A5 -19-07JUL15-1/1

Inspect Machine

Inspect machine carefully each day by walking around it before starting.

Keep all guards and shields in good condition and properly installed. Fix damage and replace worn or broken parts immediately. Pay special attention to hydraulic hoses and electrical wiring.



T6607AQ—UN—15APR13

TX,INSPECT -19-08SEP10-1/1

Stay Clear of Moving Parts

Entanglements in moving parts can cause serious injury.

Stop engine before examining, adjusting, or maintaining any part of machine with moving parts.

Keep guards and shields in place. Replace any guard or shield that has been removed for access as soon as service or repair is complete.

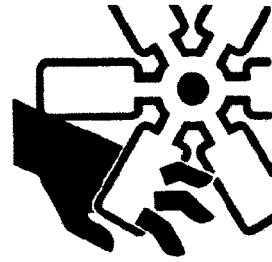

T133592 —UN—15APR13

TX,MOVING,PARTS -19-20JAN11-1/1

Avoid High-Pressure Fluids

Escaping fluid under pressure can penetrate the skin causing serious injury.

Avoid the hazard by relieving pressure before disconnecting hydraulic or other lines. Tighten all connections before applying pressure.

Search for leaks with a piece of cardboard. Protect hands and body from high-pressure fluids.

If an accident occurs, see a doctor immediately. Any fluid injected into the skin must be surgically removed within a few hours or gangrene may result. Doctors unfamiliar with this type of injury should reference a knowledgeable medical source. Such information is available from Deere & Company Medical Department in Moline, Illinois, U.S.A.

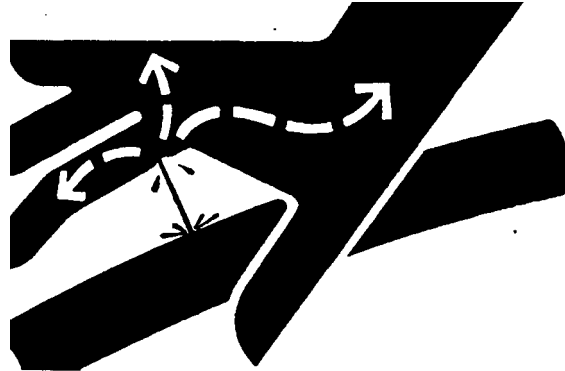

X9811 —UN—23AUG88

DX,FLUID -19-06OCT16-1/1

Avoid High-Pressure Oils

This machine uses a high-pressure hydraulic system. Escaping oil under pressure can penetrate the skin causing serious injury.

Never search for leaks with your hands. Protect hands. Use a piece of cardboard to find location of escaping oil. Stop engine and relieve pressure before disconnecting lines or working on hydraulic system.

If hydraulic oil penetrates your skin, see a doctor immediately. Injected oil must be removed surgically within hours or gangrene could result. Contact a knowledgeable medical source or the Deere & Company Medical Department in Moline, Illinois, U.S.A.

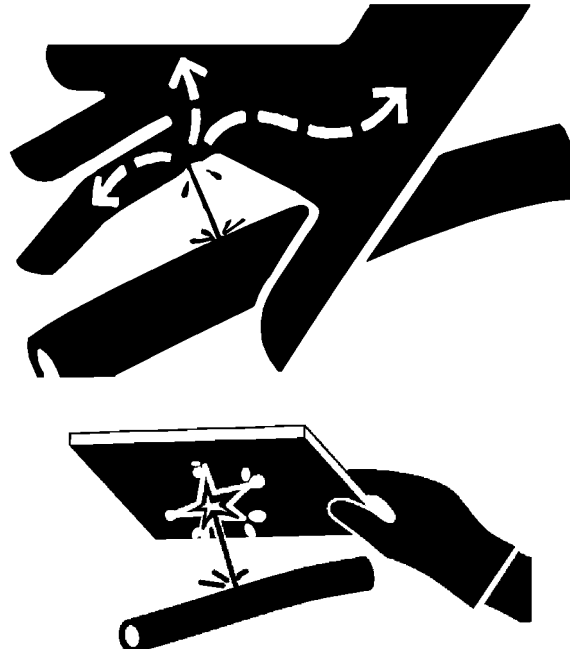

T133509 —UN—15APR13

T133840 —UN—20SEP00

TX,HPOILS -19-20JAN11-1/1

Work In Ventilated Area

Engine exhaust fumes can cause sickness or death. If it is necessary to run an engine in an enclosed area, remove the exhaust fumes from the area with an exhaust pipe extension.

If you do not have an exhaust pipe extension, open the doors and get outside air into the area.

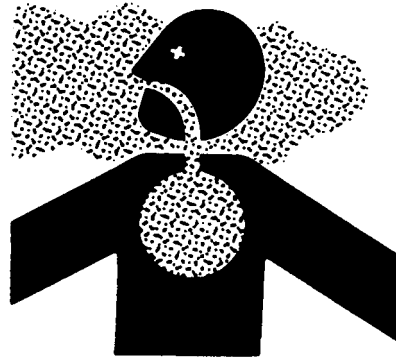

TS2220 —UN—15APR13

DX,AIR -19-17FEB99-1/1

Avoid Static Electricity Risk When Refueling

The removal of sulfur and other compounds in Ultra-Low Sulfur Diesel (ULSD) fuel decreases its conductivity and increases its ability to store a static charge.

Refineries may have treated the fuel with a static dissipating additive. However, there are many factors that can reduce the effectiveness of the additive over time.

Static charges can build up in ULSD fuel while it is flowing through fuel delivery systems. Static electricity discharge when combustible vapors are present could result in a fire or explosion.

Therefore, it is important to ensure that the entire system used to refuel your machine (fuel supply tank, transfer pump, transfer hose, nozzle, and others) is properly grounded and bonded. Consult with your fuel or fuel system supplier to ensure that the delivery system is in compliance with fueling standards for proper grounding and bonding practices.

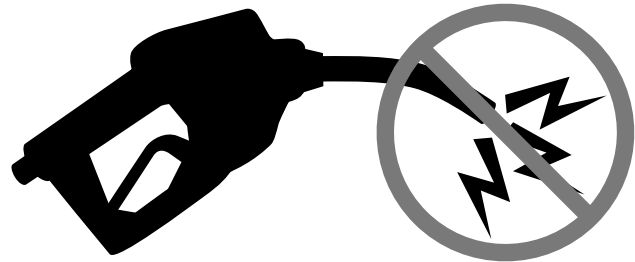

RG22142 —UN—17MAR14

RG21992 —UN—21AUG13

DX,FUEL,STATIC,ELEC -19-12JUL13-1/1

Prevent Fires

Handle Fluids Safely: All fuels, most lubricants, and some coolant mixtures are flammable. Store flammable fluids away from fire hazards. Never refuel machine while smoking or when near sparks or flame.

Clean Machine Regularly: Keep flammable debris (trash, leaves, twigs, straw, and so forth), grease and oil from accumulating in engine compartment, around fuel lines, hydraulic lines, exhaust components, and electrical wiring. Never store oily rags or flammable materials inside a machine compartment.

Maintain Hoses, Tubes, and Wiring: Replace hoses and tubes immediately if they begin to leak, and clean up any oil spills. Examine electrical wiring and connectors frequently for damage.

Keep A Fire Extinguisher Available: Always keep a multipurpose fire extinguisher on or near the machine. Know how to use an extinguisher properly.

Be Aware of the Operating Environment: Airborne debris may contain sparks or embers. Do not operate near any flame.



T133553 —UN—07SEP00



T133554 —UN—07SEP00

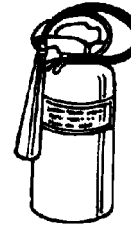

TX,PREVENT,FIRE -19-09JUN16-1/1

T133552 —UN—15APR13

In Case of Machine Fire

CAUTION: Avoid personal injury from exposed flames. Maintain safe distance.

- Turn the engine off.
- Turn the battery disconnect switch to the OFF position (if equipped).
- If possible, fight the fire using the portable fire extinguisher or other fire suppression equipment (if equipped).
- Ensure that the fire does not spread to the surrounding area. Do not risk injury. If a fire is too far advanced, do not try to extinguish fire.
- Call for help.



In Case of Machine Fire

CN93077,00000B2 -19-05FEB19-1/1

TS227 —UN—15APR13

Prevent Battery Explosions

Keep sparks, lighted matches, and open flame away from the top of battery. Battery gas can explode.

Never check battery charge by placing a metal object across the posts. Use a voltmeter or hydrometer.

Do not charge a frozen battery; it may explode. Warm battery to 16°C (60°F).

Keep battery electrolyte levels properly maintained.



Battery Explosions

KR46761,00010B4 -19-26JAN16-1/1

TS204—UN—15APR13

Handle Chemical Products Safely

Direct exposure to hazardous chemicals can cause serious injury. Potentially hazardous chemicals used with John Deere equipment include such items as lubricants, coolants, paints, and adhesives.

A Material Safety Data Sheet (MSDS) provides specific details on chemical products: physical and health hazards, safety procedures, and emergency response techniques.

Check the MSDS before you start any job using a hazardous chemical. That way you will know exactly what the risks are and how to do the job safely. Then follow procedures and recommended equipment.

(See your John Deere dealer for MSDS's on chemical products used with John Deere equipment.)

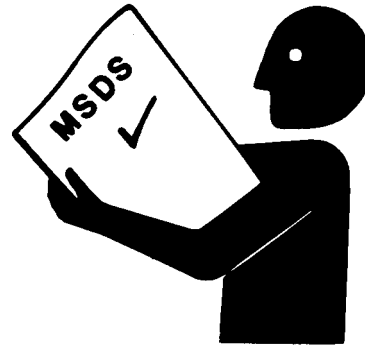

DX,MSDS,NA -19-03MAR93-1/1

TS1132—UN—15APR13

Handle Starting Fluid Safely

Starting fluid is highly flammable.

Keep all sparks and flame away when using it. Keep starting fluid away from batteries and cables.

To prevent accidental discharge when storing the pressurized can, keep the cap on the container, and store in a cool, protected location.

Do not incinerate or puncture a starting fluid container.

Do not use starting fluid on an engine equipped with glow plugs or an air intake heater.



DX,FIRE3 -19-14MAR14-1/1

TS1356—UN—18MAR92

Decommissioning — Proper Recycling and Disposal of Fluids and Components

Safety and environmental stewardship measures must be taken into account when decommissioning a machine and/or component. These measures include the following:

- Use appropriate tools and personal protective equipment such as clothing, gloves, face shields or glasses, during the removal or handling of objects and materials.
- Follow instructions for specialized components.
- Release stored energy by lowering suspended machine elements, relaxing springs, disconnecting the battery or other electrical power, and releasing pressure in hydraulic components, accumulators, and other similar systems.
- Minimize exposure to components which may have residue from agricultural chemicals, such as fertilizers and pesticides. Handle and dispose of these components appropriately.
- Carefully drain engines, fuel tanks, radiators, hydraulic cylinders, reservoirs, and lines before recycling components. Use leak-proof containers when draining fluids. Do not use food or beverage containers.
- Do not pour waste fluids onto the ground, down a drain, or into any water source.
- Observe all national, state, and local laws, regulations, or ordinances governing the handling or disposal of waste fluids (example: oil, fuel, coolant, brake fluid);

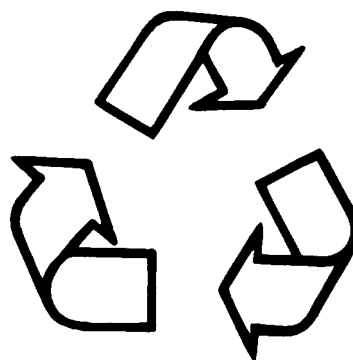

TS1133 —UN—15APR13

- filters; batteries; and, other substances or parts. Burning of flammable fluids or components in other than specially designed incinerators may be prohibited by law and could result in exposure to harmful fumes or ashes.
- Service and dispose of air conditioning systems appropriately. Government regulations may require a certified service center to recover and recycle air conditioning refrigerants which could damage the atmosphere if allowed to escape.
 - Evaluate recycling options for tires, metal, plastic, glass, rubber, and electronic components which may be recyclable, in part or completely.
 - Contact your local environmental or recycling center, or your John Deere dealer for information on the proper way to recycle or dispose of waste.

DX,DRAIN -19-01JUN15-1/1

Exhaust Filter Ash Handling and Disposal

CAUTION: Under federal, state, and local laws or regulations, exhaust filter ash can be classified as a hazardous waste. Hazardous waste must be disposed of in accordance with all applicable federal, state, and local laws or regulations

governing hazardous waste disposal. Only a qualified service provider should remove ash from the exhaust filter. Personal protective equipment and clothing, maintained in a sanitary and reliable condition, should be used when handling and cleaning exhaust filter. See your authorized dealer for exhaust filter ash handling and disposal.

TX,ASH,DISP -19-20JAN11-1/1

Prepare for Emergencies

Be prepared if a fire starts.

Keep a first aid kit and fire extinguisher handy.

Keep emergency numbers for doctors, ambulance service, hospital, and fire department near your telephone.

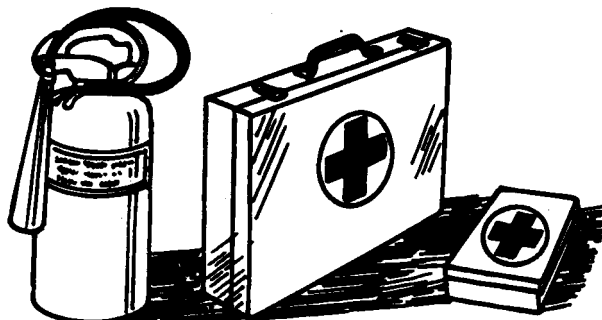

TS291 —UN—15APR13

DX,FIRE2 -19-03MAR93-1/1

Clean Debris from Machine

Keep engine compartment, radiator, batteries, hydraulic lines, exhaust components, fuel tank, and operator's station clean and free of debris.

Clean any oil spills or fuel spills on machine surfaces.

Temperature in engine compartment could go up immediately after engine is stopped. **BE ON GUARD FOR FIRES DURING THIS PERIOD.**

Open access door(s) to cool the engine faster, and clean engine compartment.

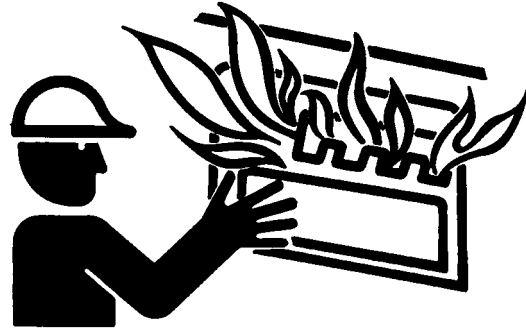

T6669AG —UN—15APR13

TX,DEBRIS -19-20JAN11-1/1

Add Cab Guarding for Special Uses

Special work situations or machine attachments could create an environment with falling or flying objects. Working near an overhead bank, demolition work, using a hydraulic hammer or winch, working in a forestry application or wooded area, or working in a waste management application, for example, could require added guarding to protect the operator.

Additional level II FOPS (falling object protective structure), forestry protection packages, and special screens or guarding should be installed when falling or flying objects could enter or damage the machine. A rear screen should always be used with a winch to protect against a snapping cable. Before operating in any special work environments, follow the operator protection recommendations of the manufacturer of any specialized attachment or equipment. Contact your authorized John Deere dealer for information on protective guarding.

TX,CABGUARD -19-12FEB13-1/1

Use Steps and Handholds Correctly

Prevent falls by facing the machine when you get on and off. Maintain 3-point contact with steps and handrails. Never use machine controls as handholds.

Use extra care when mud, snow, or moisture present slippery conditions. Keep steps clean and free of grease or oil. Never jump when exiting machine. Never mount or dismount a moving machine.

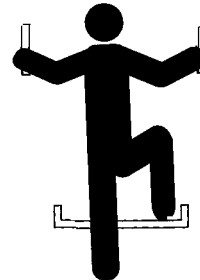

T133468 —UN—15APR13

TX,STEPS -19-09FEB11-1/1

Start Only From Operator's Seat

Avoid unexpected machine movement. Start engine only while sitting in operator's seat. Ensure that all controls and working tools are in proper position for a parked machine.

Never attempt to start engine from the ground. Do not attempt to start engine by shorting across the starter solenoid terminals.



T133715 —UN—15APR13

TX,SOFOS -19-20JAN11-1/1

Use and Maintain Seat Belt

Use seat belt when operating machine. Remember to fasten seat belt when loading and unloading from trucks and during other uses.

Examine seat belt frequently. Be sure that webbing is not cut or torn. Replace seat belt immediately if any part is damaged or does not function properly.

The complete seat belt assembly should be replaced every three years, regardless of appearance.



**USE
SEAT
BELT**

T133716 -19-17APR13

TX,SEAT,BELT -19-20JAN11-1/1

Prevent Unintended Machine Movement

Be careful not to accidentally actuate control levers when coworkers are present. Pull pilot shutoff lever to locked (UP) position during work interruptions. Pull pilot shutoff lever to locked (UP) position and stop engine before allowing anyone to approach machine.

Always lower work equipment to the ground and pull pilot shutoff lever to locked (UP) position before standing up or leaving the operator's seat. Stop engine before exiting.

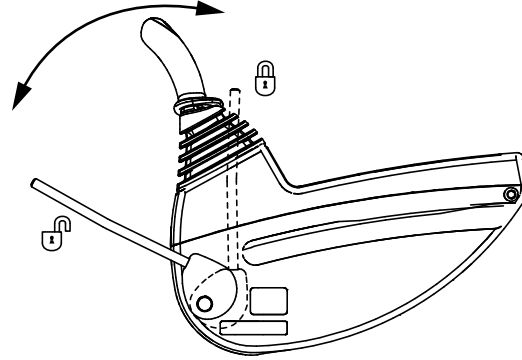

T216779 -UN-22NOV05

VD76477,000036D -19-19APR11-1/1

Avoid Work Site Hazards

Avoid contact with gas lines, buried cables, and water lines. Call utility line location services to identify all underground utilities before digging.

Prepare work site properly. Avoid operating near structures or objects that could fall onto the machine. Clear away debris that could move unexpectedly if run over.

Avoid boom or arm contact with overhead obstacles or overhead electrical lines. Never move any part of machine or load closer than 3 m (10 ft) plus twice the line insulator length to overhead wires.

Keep bystanders clear at all times. Keep bystanders away from raised booms, attachments, and unsupported loads. Avoid swinging or raising booms, attachments, or loads over or near bystanders. Use barricades or a signal person to keep vehicles and pedestrians away. Use a signal person if moving machine in congested areas or where visibility is restricted. Always keep signal person in view. Coordinate hand signals before starting machine.

Operate only on solid footing with strength sufficient to support machine. When working close to an excavation, position travel motors away from the hole.

Reduce machine speed when operating with tool on or near ground when obstacles may be hidden (e.g., during snow removal or clearing mud, dirt, etc). At high speeds, hitting obstacles (rocks, uneven concrete, or manholes) can cause a sudden stop. Always wear seat belt.

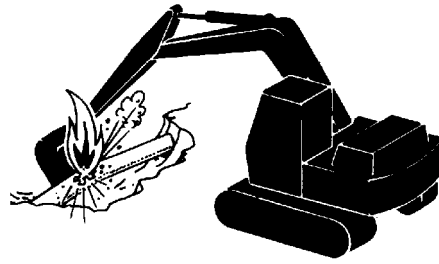

Work Site Hazards



Work Site Hazards

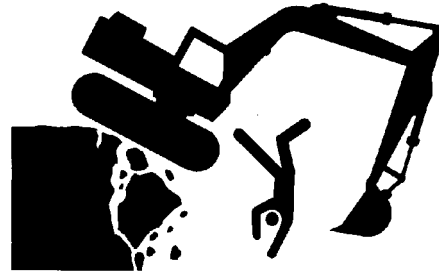

Work Site Hazards

TX03679,0001748 -19-08JUL15-1/1

T134986—UN—31OCT00

T133650—UN—27SEP00

T133549—UN—24AUG00

Keep Riders Off Machine

Only allow operator on machine.

Riders are subject to injury. They may fall from machine, be caught between machine parts, or be struck by foreign objects.

Riders may obstruct operator's view or impair the ability to operate machine safely.

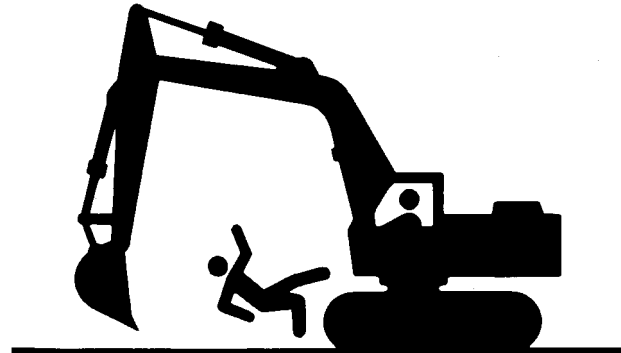

Keep Riders Off Machine

TX03679,0001726 -19-30JUN16-1/1

T7273AH—UN—08JUN90

Avoid Backover Accidents

Before moving machine, be sure that all persons are clear of machine path. Turn around and look directly for best visibility. Use mirrors to assist in checking all around machine. Keep windows and mirrors clean, adjusted, and in good repair.

Be certain reverse warning alarm is working properly.

Use a signal person when backing if view is obstructed or when in close quarters. Keep signal person in view at all times. Use prearranged hand signals to communicate.

Do not rely on the rear camera and radar object detection systems, if equipped, to determine if personnel are behind the machine. The system has limitations due to maintenance practices, environmental conditions, and operating range.



TX,AVOID,BACKOVER -19-04MAR16-1/1

PC10857XW—UN—15APR13

Avoid Machine Tip Over

Use seat belt at all times.

Do not jump if the machine tips. Operator will be unlikely to jump clear and the machine may crush the operator.

Load and unload from trucks or trailers carefully. Be sure truck is wide enough and on a firm level surface. Use loading ramps and attach them properly to truck bed. Avoid trucks with steel beds because tracks slip more easily on steel.

Be careful on slopes. Use extra care on soft, rocky or frozen ground. Machine may slip sideways in these conditions. When traveling up or down slopes, keep the bucket on uphill side and just above ground level.

Be careful with heavy loads. Using oversize buckets or lifting heavy objects reduces machine stability. Extending a heavy load or swinging it over side of undercarriage may cause machine to tip.

Ensure solid footing. Use extra care when operating near banks or excavations that may cave-in and cause machine to tip or fall.



**USE
SEAT
BELT**

Use Seat Belt

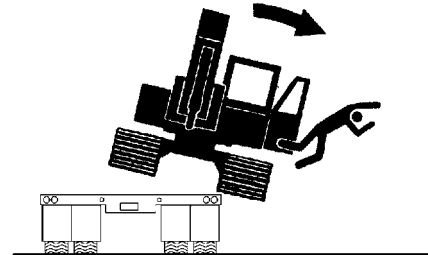

Unloading Machine

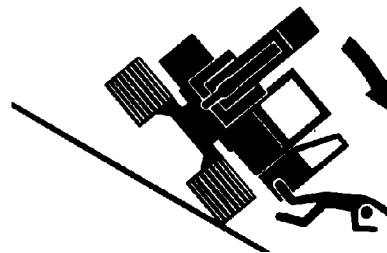

Do Not Jump

TX03679,00016DF -19-30JUN16-1/1

T133716—19—17APR13

T133545—UN—15SEP00

T133803—UN—27SEP00

Use Special Care When Lifting Objects

Never use this machine to lift people.

Never lift a load above another person. Keep bystanders clear of all areas where a load might fall if it breaks free. Do not leave the seat when there is a raised load.

Do not exceed lift capacity limits posted on machine and in this manual. Extending heavy loads too far or swinging over undercarriage side may cause machine to tip over.

Use proper rigging to attach and stabilize loads. Be sure slings or chains have adequate capacity and are in good condition. Use tether lines to guide loads and prearranged hand signals to communicate with co-workers.

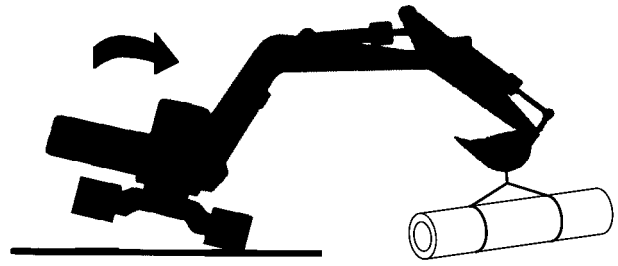

Use Special Care When Lifting Objects

T133839 —UN—27SEP00

TX03679,00016E1 -19-08JUL15-1/1

Inspect and Maintain ROPS

A damaged rollover protective structure (ROPS) should be replaced, not reused.

The protection offered by ROPS could be impaired if ROPS is subjected to structural damage, is involved in an overturn incident, or is in any way altered by welding, bending, drilling, or cutting.

If ROPS was loosened or removed for any reason, inspect it carefully before operating the machine again.

To maintain the ROPS:

- Replace missing hardware using correct grade hardware.
- Check hardware torque.
- Check isolation mounts for damage, looseness, or wear; replace them if necessary.
- Check ROPS for cracks or physical damage.

TX,ROPS -19-20JAN11-1/1

Travel Safely

When working on steep slopes, travel as straight up and down as possible to prevent roll over.

DO NOT PARK ON A HILLSIDE OR AN INCLINE.

Always park the machine on level ground.

Know the location of bystanders before moving the machine.

Always keep the reverse/travel warning alarm in working condition. The alarm warns bystanders when the machine starts to move in reverse.

Use a signal person when moving the machine in congested areas. Coordinate hand signals before starting the machine.

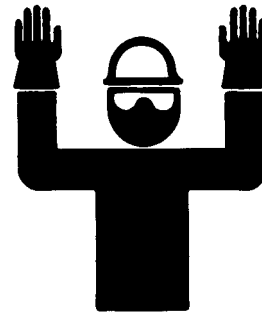

Travel Safely

T6964AD —UN—20DEC88

KR46761,00010AB -19-05FEB19-1/1

Prevent Acid Burns

Sulfuric acid in battery electrolyte is poisonous. It is strong enough to burn skin, eat holes in clothing, and cause blindness if splashed into eyes.

Avoid the hazard by:

1. Filling batteries in a well-ventilated area.
2. Wearing eye protection and rubber gloves.
3. Avoiding breathing fumes when electrolyte is added.
4. Avoiding spilling or dripping electrolyte.
5. Use proper jump start procedure.

If you spill acid on yourself:

1. Flush your skin with water.
2. Apply baking soda or lime to help neutralize the acid.
3. Flush your eyes with water for 15—30 minutes. Get medical attention immediately.

If acid is swallowed:

1. Do not induce vomiting.
2. Drink large amounts of water or milk, but do not exceed 2 L (2 quarts).
3. Get medical attention immediately.

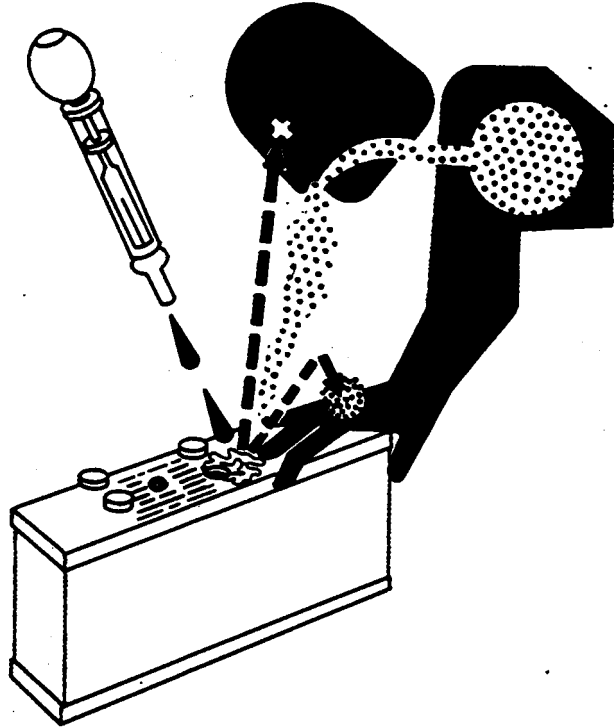

DX,POISON -19-21APR93-1/1

Add and Operate Attachments Safely

Always verify compatibility of attachments by contacting your authorized dealer. Adding unapproved attachments could affect machine stability or reliability and could create a hazard for others near the machine.

Ensure that a qualified person is involved in attachment installation. Add guards to machine if operator protection

is required or recommended. Verify that all connections are secure and attachment responds properly to controls.

Carefully read attachment manual and follow all instructions and warnings. In an area free of bystanders and obstructions, carefully operate attachment to learn its characteristics and range of motion.

TX,ATTACH -19-20JAN11-1/1

Park and Prepare for Service Safely

Warn others of service work. Always park and prepare machine for service or repair properly.

- Park machine on a level surface and lower equipment to the ground.
- Place pilot shutoff lever in locked (UP) position. Stop engine and remove key.
- Attach a “Do Not Operate” tag in an obvious place in the operator’s station.

Securely support machine or attachment before working under it.

- Do not support machine with any hydraulically actuated equipment.
- Do not support machine with cinder blocks or wooden pieces that may crumble or crush.
- Do not support machine with a single jack or other devices that may slip out of place.

Understand service procedures before beginning repairs. Keep service area clean and dry. Use two people whenever the engine must be running for service work.



Do Not Operate Tag

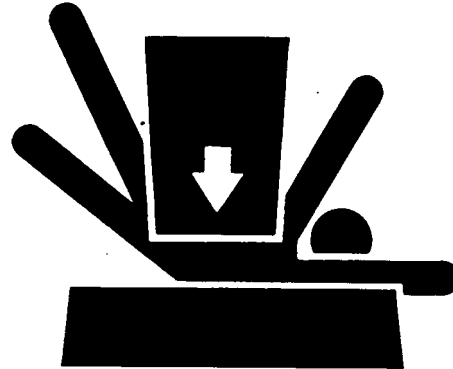

Support Machine Properly

OUT4001,000089A -19-02JUL15-1/1

T133332—19—17APR13

TS229—UN—23AUG88

Service Cooling System Safely

Explosive release of fluids from pressurized cooling system can cause serious burns.

Do not service radiator through the radiator cap. Only fill through the surge tank filler cap. Shut off engine. Only remove surge tank filler cap when cool enough to touch with bare hands. Slowly loosen cap to relieve pressure before removing completely.



TX,SURGE -19-19JAN11-1/1

TS281—UN—15APR13